



APRIL 25 2022

UAS Operations in Extreme Weather Environments

Case Studies and Technological Solutions



MISSION

Enable uncrewed aircraft systems (UAS) to operate year round to provide rich data sets in any weather condition.

PROBLEM

The inability to operate safely in all terrain, weather conditions, and over long distances is becoming an increasingly limiting factor in the adoption of UAS for commercial applications.



SOLUTION

Specialized vehicle design, subsystems, and control algorithms to produce industrial grade equipment.

VALUE PROPOSITION

Platforms that simplify operations through true autonomy while providing 24/7 operational capabilities



TECHNOLOGY PORTFOLIO



BlackSwift 



BlackSwift 



BlackSwift 



SwiftCore 



- ▶ End-to-end UAS IP including the user interface, ground station, communications protocol, avionics, control algorithms, and vehicle design
- ▶ Advanced sensing capabilities
 - ▶ Airdata systems capable of mitigating ice and heavy precipitation
 - ▶ Vision based systems for GPS denied navigation and automated emergency landing
 - ▶ Machine learning based system for fault prediction and detection
- ▶ Extreme weather based design
 - ▶ Tool-less assembly designed to be used with gloves
 - ▶ Ingress protection from abrasive volcanic ash and corrosive gasses
- ▶ Industry leading wind based control and path planning
 - ▶ Energy aware warning system for rapidly evolving flight conditions
 - ▶ Energy extraction through dynamic soaring to extend mission duration
- ▶ Years of experience designing vehicles for observations of weather events

MULTI-MISSION FIXED WING UAS

S2 UAS



- ▶ Rugged, modular design
- ▶ Mature, field proven SwiftCore avionics
- ▶ Multi-sensor payload configurations possible
- ▶ BVLOS proven
- ▶ Field fixable
- ▶ NASA and NOAA certified

Modular Field-Swappable Payload System

Enables rapid changes of the payload in the field using a common power, data, and mechanical interface without any specialized tools.

S2 UAS

SPECIFICATIONS

▶ Mission Capabilities

Flight Ceiling 4500 m (14,000 ft)

Max Winds Endured 15 m/s (30 kts)

▶ Flight Characteristic (6 kft density alt)

Flight Speed 12 m/s (24 kts) stall, 19 m/s (37 kts) cruise

Flight Time 110 max, 90 min nominal

Range 110 km (60 nm) max, 92 km (50 nm) nominal

▶ Vehicle Characteristics

Weight 9.3 kg (20.5 lbs) max takeoff weight

Wingspan 3.0 m (10.0 ft)

▶ Payload Capabilities

Nose Cone Dimensions 20.3 cm (8 in) diameter, 63.2 cm (24.9 in) length

Power available 50 W total

Payload Weight 2.3 kg (5 lbs) max with rail launch

Geotagging Accuracy Typically < 1m in all directions



SENSOR SUITES AND APPLICATIONS



Typical UAS Payload Offerings



Visual or thermal spectral cameras provide high resolution data that can be combined into an orthomosaic or three-dimensional map

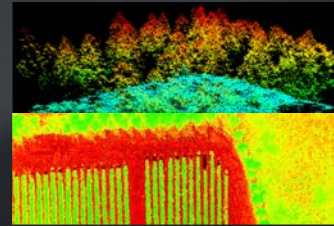

Lidar / Multispectral specialized applications make use of scanning lidar or multi / hyperspectral cameras for data capture.

The S2 UAS Modular Payload System Simplifies Sensor Integration - Some Examples of Flown Payloads



High-altitude, high-latitude atmospheric research studies in Greenland operating in temperatures near -20C at altitudes up to 14,000 ft. analyzing water vapor.



Coastline monitoring using a combination of thermal and hyperspectral payloads with a multispectral camera array for Landsat-8 OLI and S-NPP VIIRS instrument calibration.



Airborne measurements of trace gases including carbon dioxide (CO₂), sulfur dioxide (SO₂), methane (CH₄), and hydrogen sulfide (H₂S) as well as generation of orthomosaic, thermal and 3D data products.



Nighttime in situ measurements of wildfire plumes and remote measurements of wildfire properties utilizing multiple sensors capable of research-quality measurements of CO₂, CO, aerosol, RH, ρ and T.



Volcano plume monitoring with sensors specifically designed to measure selected gases and a nephelometer to assess volcanic particle size and distribution.



Soil moisture mapping (up to 600 acres per flight) using multiple sensors including an L-band radiometer capable of measuring soil moisture content up to 10 cm below the ground.

SAFE TO LAND

AUTOMATED HAZARD MITIGATION

- ▶ System runs continuously during a flight
- ▶ Segmentation map is converted to map of hazards and safe areas
- ▶ The system attempt to fit a landing corridor in the map
- ▶ If a landing area can be safely fit, its GPS coordinates are estimated and saved
- ▶ If an engine failure is detected the landing plan memory is searched and the closest landing area is selected and sent to the autopilot
- ▶ The pilot has the final say in choosing to execute the emergency plan

Segmentation Map

Safe to VTOL

Safe to Land

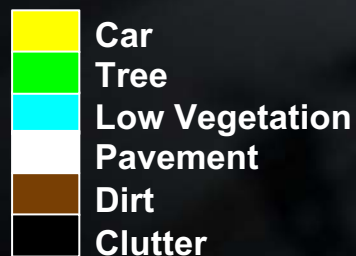
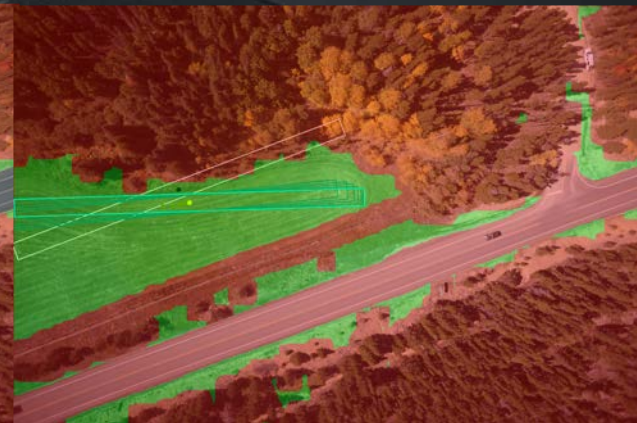
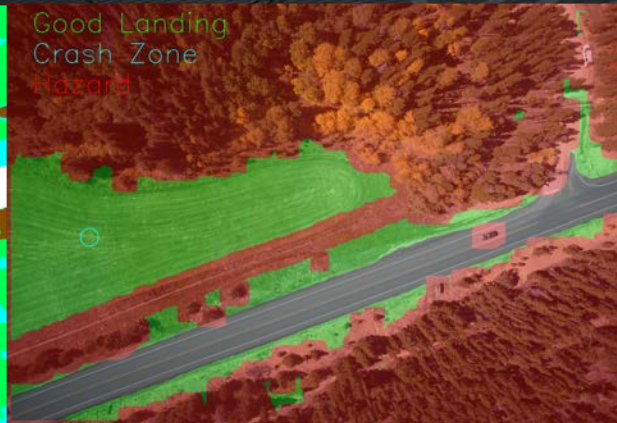
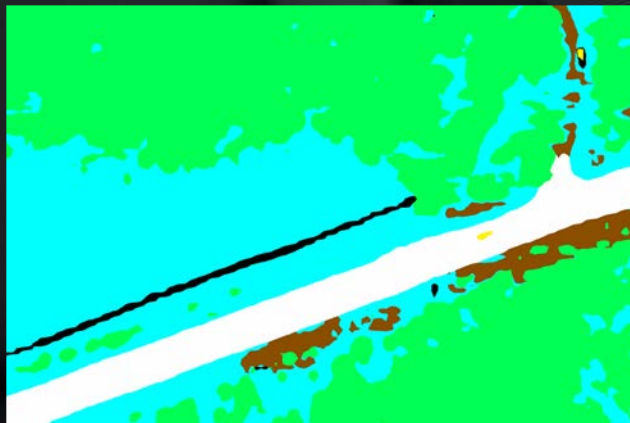

SAFE TO LAND

SUBURBAN EXAMPLE

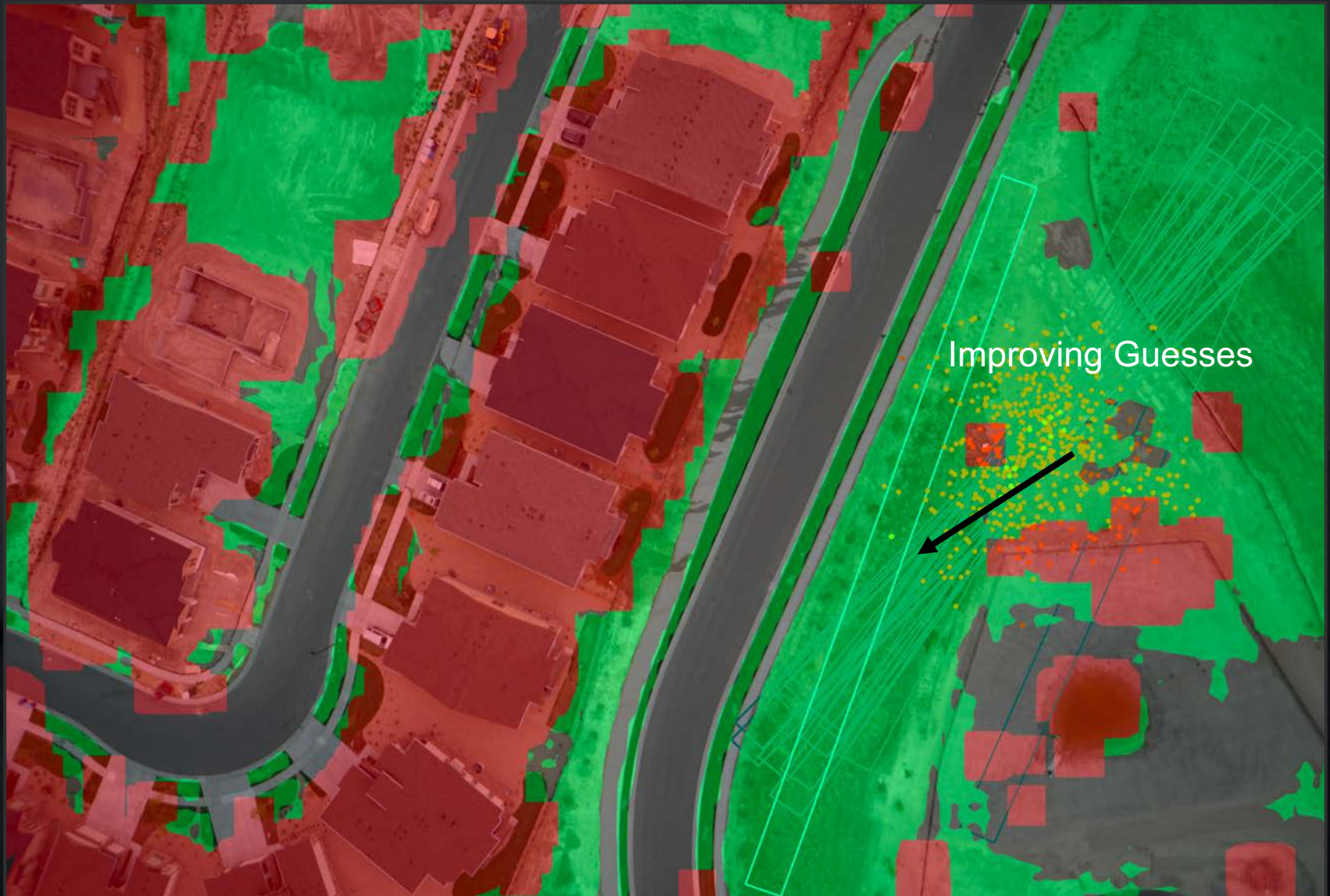

GPS DENIED NAVIGATION

COMBINING VISION AND RADIO SIGNALS

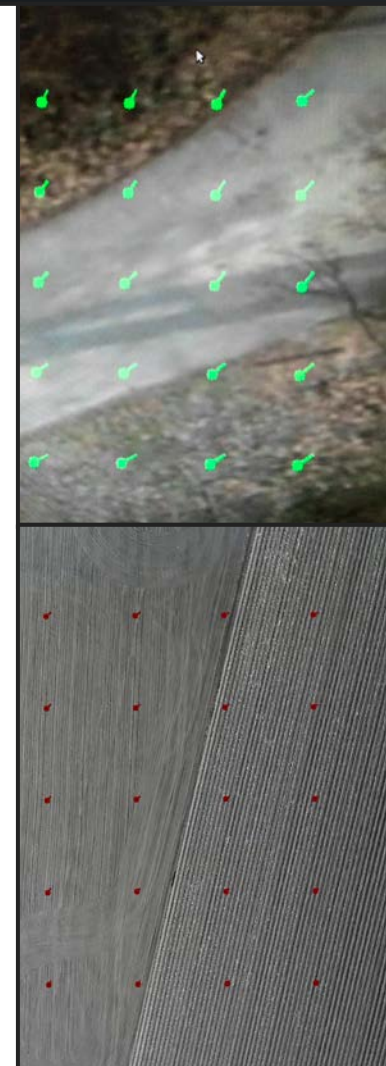
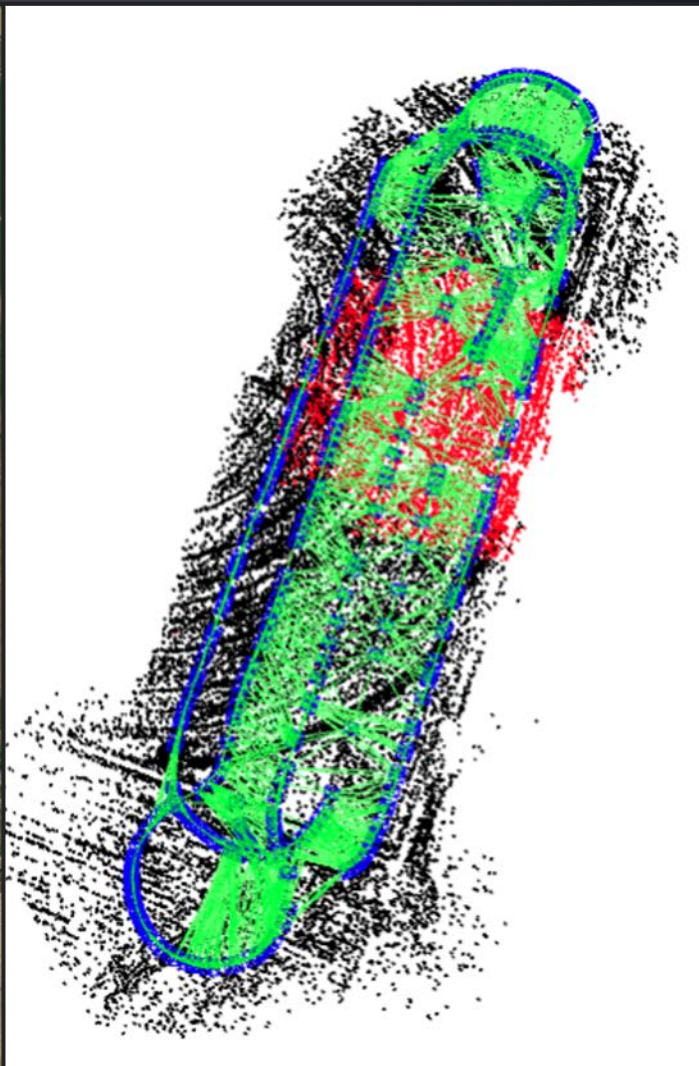
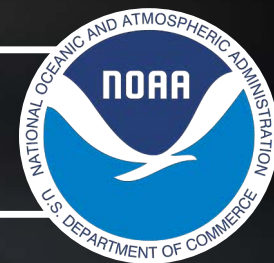

AUGMENTED ONBOARD INTELLIGENCE

NASA ARMSTRONG SBIR

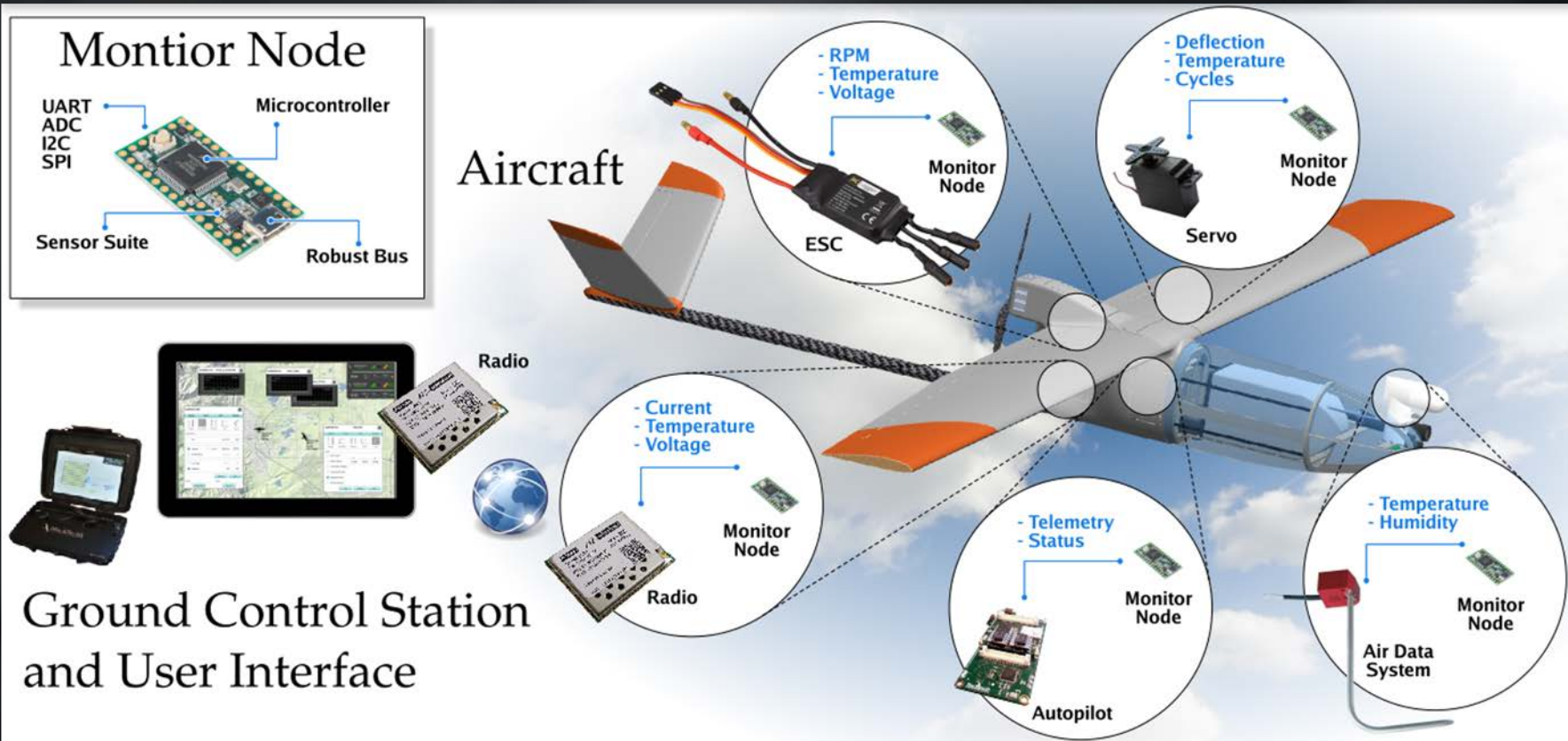
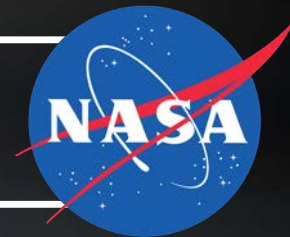

BENCH TESTING SUBSYSTEMS

CHARACTERIZATION OF FAILURE MODES

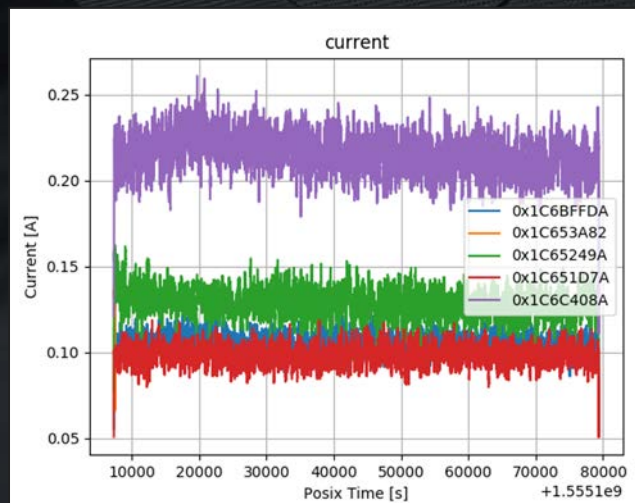
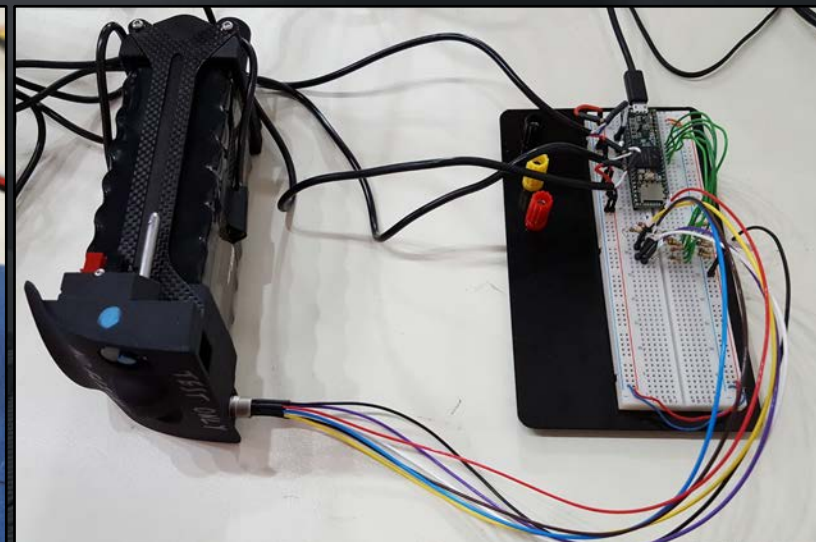
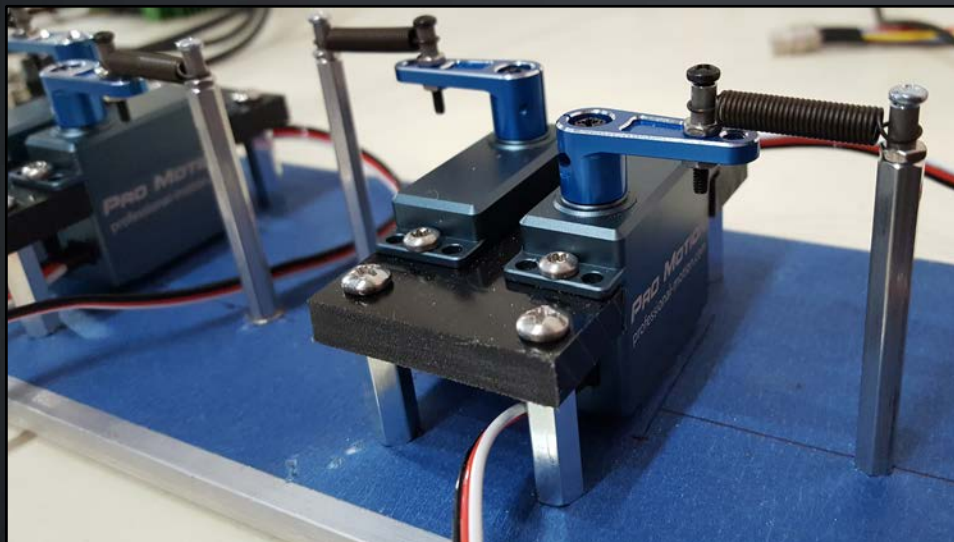
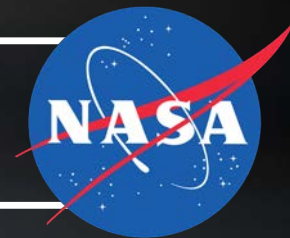

PREVENTATIVE MAINTENANCE

MACHINE LEARNING

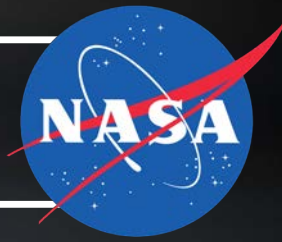

- ▶ Outliers easily identified out of large amounts of data
- ▶ Quickly identifies subsystem issues
- ▶ Potential solution for icing detection

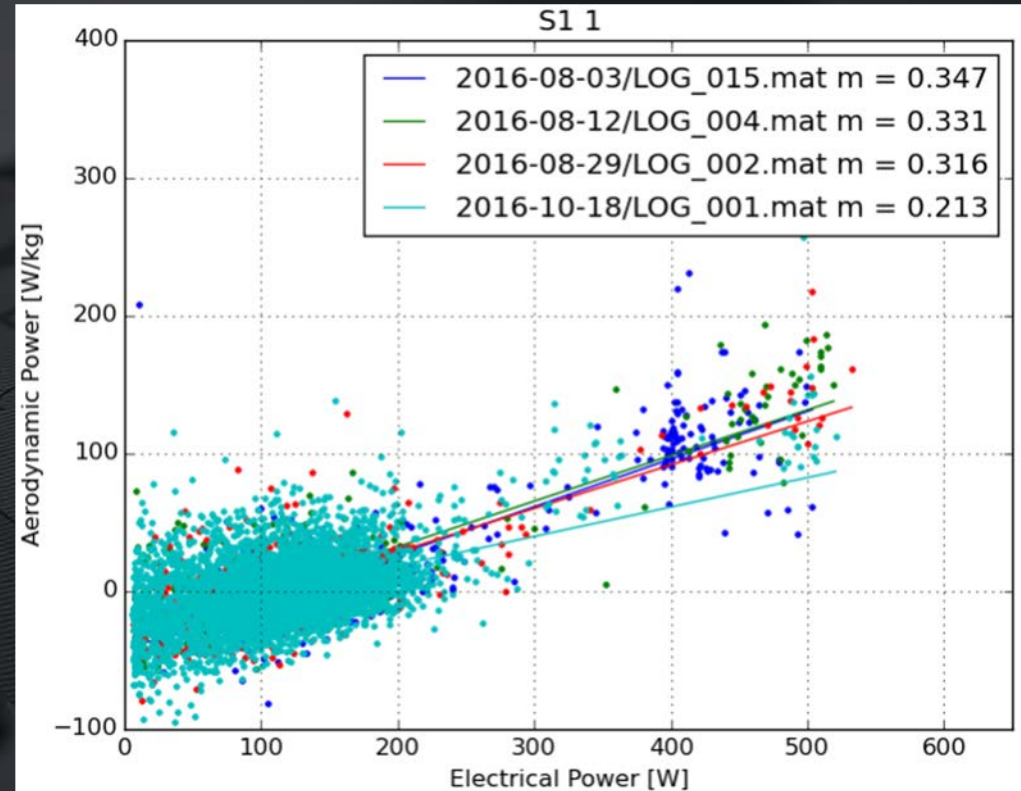

Flight Testing - Icing

FLIGHT TESTING

ICING CONDITIONS



SWIFTAB USER INTERFACE

INTUITIVE AND POWERFUL

BST's proprietary and intuitive SwiftTab GUI focuses on data gathering, allowing the operator to focus on the mission at hand rather than extraneous information.

Safety is built into the system, including an electronic centralized aircraft monitor-like system to simplify identifying and addressing failures using fault trees

The system also contains a stand-alone simulator with the ability to inject faults during training.

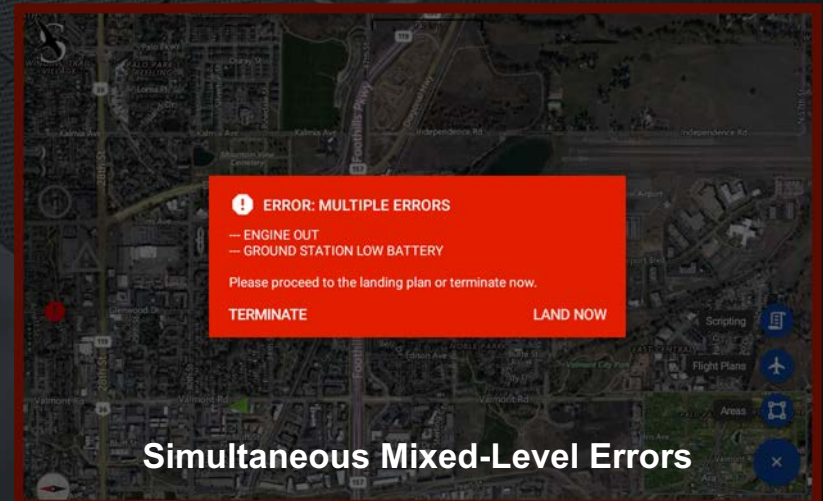
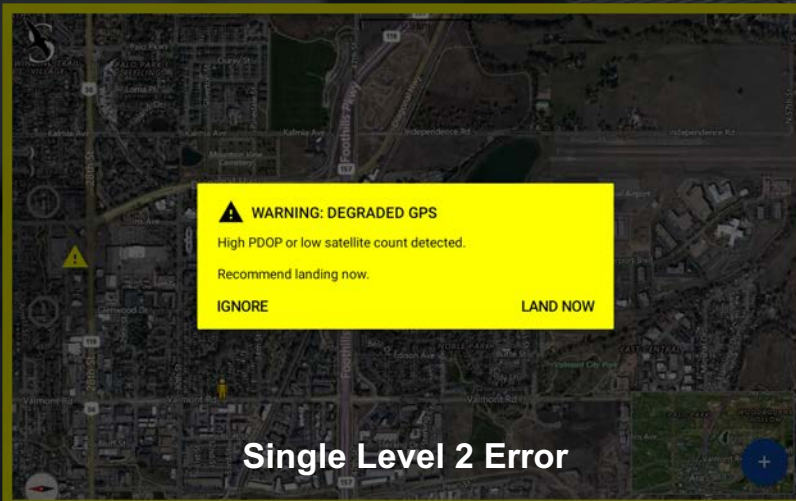

MAKUSHIN VOLCANO MONITORING



- ▶ Black Swift S2 fixed wing UAS
- ▶ Pathfinder BVLOS UAS operations
 - ▶ No string of observers
 - ▶ No special ground equipment
- ▶ Adverse conditions
 - ▶ > 50kt winds
 - ▶ > 1600 ft/min downdrafts
- ▶ Precipitation and clouds
- ▶ Near freezing conditions
- ▶ Sensor directed flight control

FLIGHT AREA

Requested TFR Boundary (starting 2 miles southwest of runway)

Planning, notification, and safety

- ▶ FAA COA with NASA Airworthiness
- ▶ Contact with local operators and NOTAM
- ▶ CTAF Monitoring
- ▶ Onboard ADS-B
- ▶ Visual Line of sight near airport

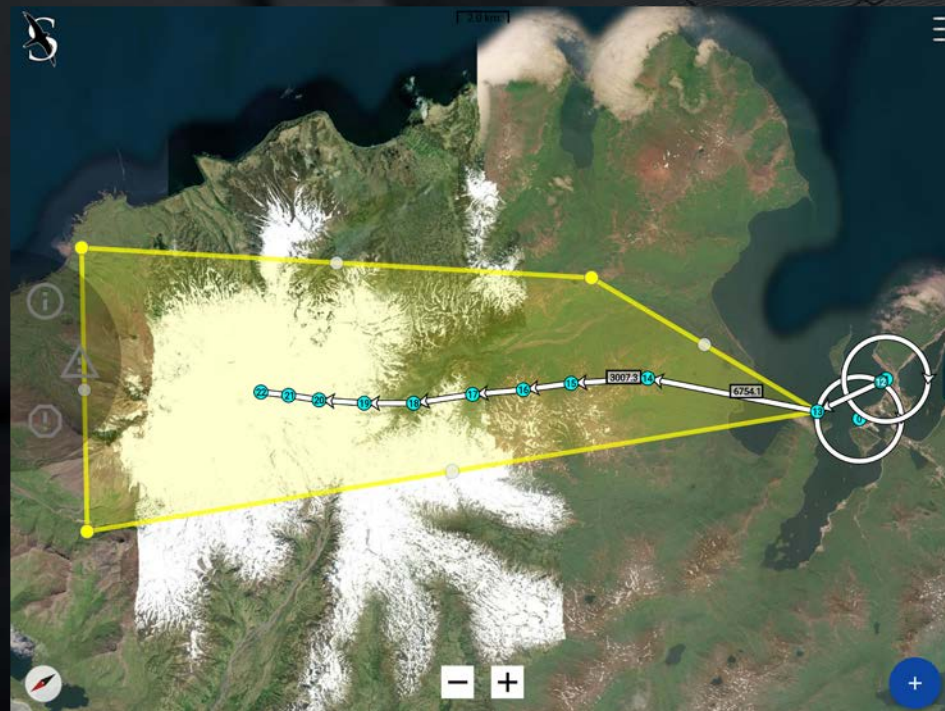

FLIGHT PLANNING

AIRSPACE AND TERRAIN

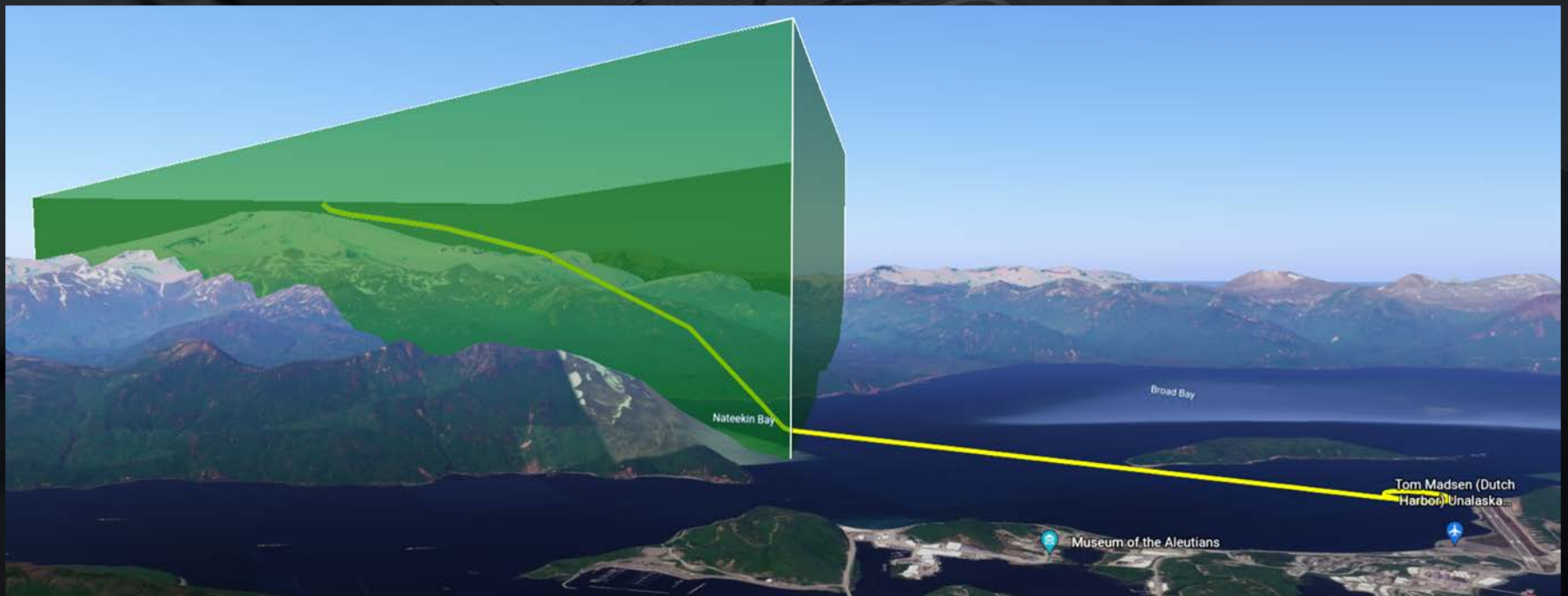

FLIGHT PLANNING

WIND ESTIMATION

Trace Gas Payload

Photogrammetry Payload

Summit Time

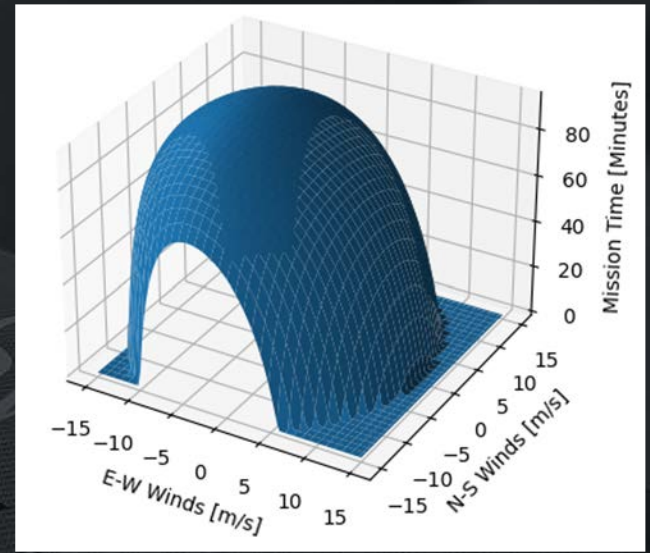
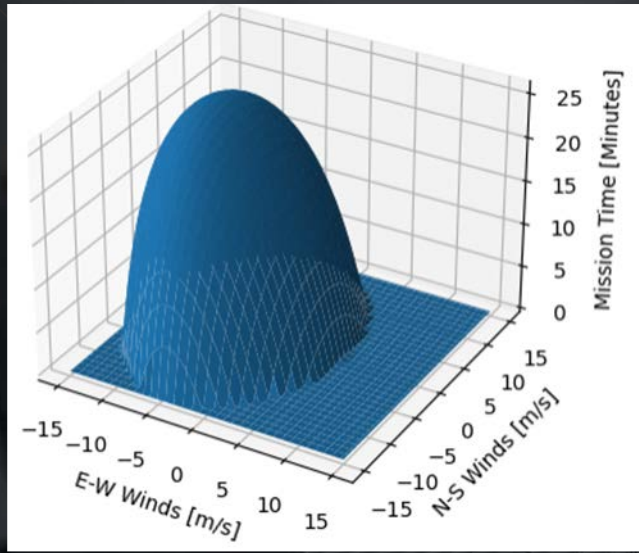

Go-No/Go Winds

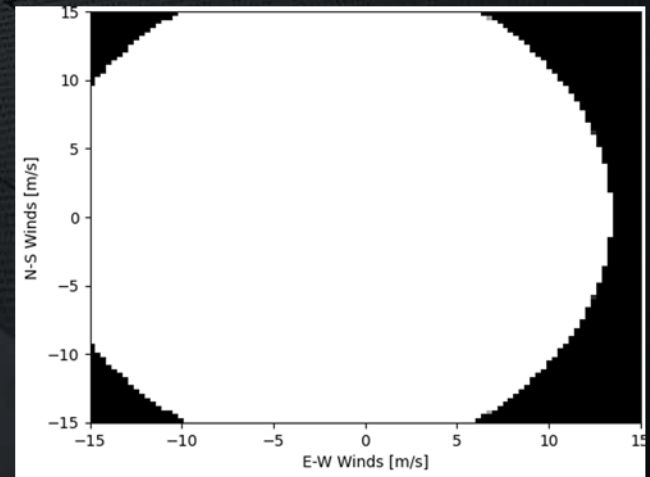
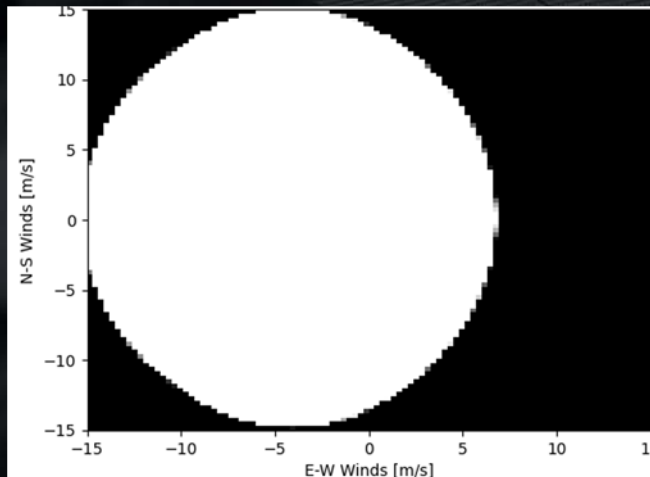

BST SWIFTFLOW WIND PROBE

HERITAGE

- ▶ 3D Wind Probe Designed at BST to be accurate yet rugged
 - ▶ Has been used on both manned and unmanned aircraft for studies.
 - ▶ Low cost achieved through accurate 3D printing.
 - ▶ Full sensor suite with co-located IMU, magnetometer and GPS
 - ▶ Operated in a variety of conditions: Arctic, tornadic thunderstorms, etc.

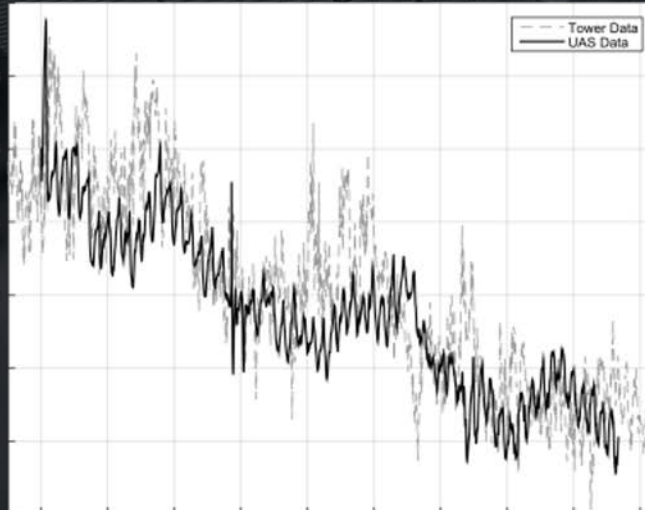
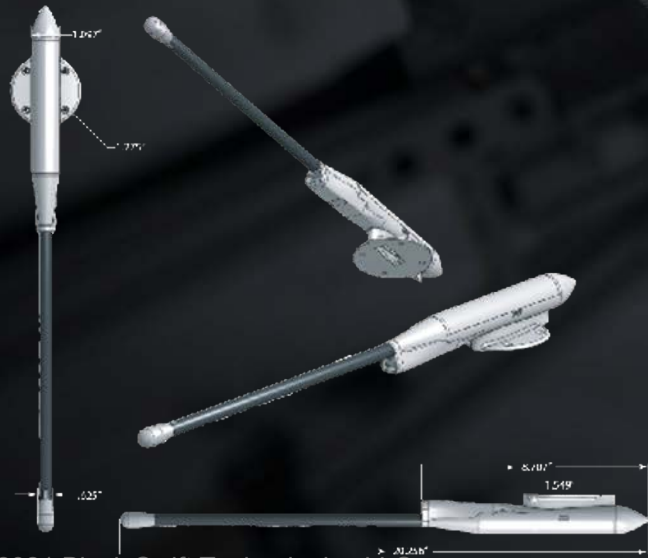

WIND SENSING FROM 3D PRINTED PARTS

TUNNEL CALIBRATION

- ▶ 9th order polynomial fit seems to provide good results
 - ▶ Computation of $c\alpha$, $c\beta$, and cq
 - ▶ Non-linear, but has good symmetry.
- ▶ Probe positioned at 900 points
 - ▶ +/- 15° α & β at 1° intervals
 - ▶ > 1000 measurements at each position.
 - ▶ ~10⁶ total measurements
 - ▶ 3 hour total run time.

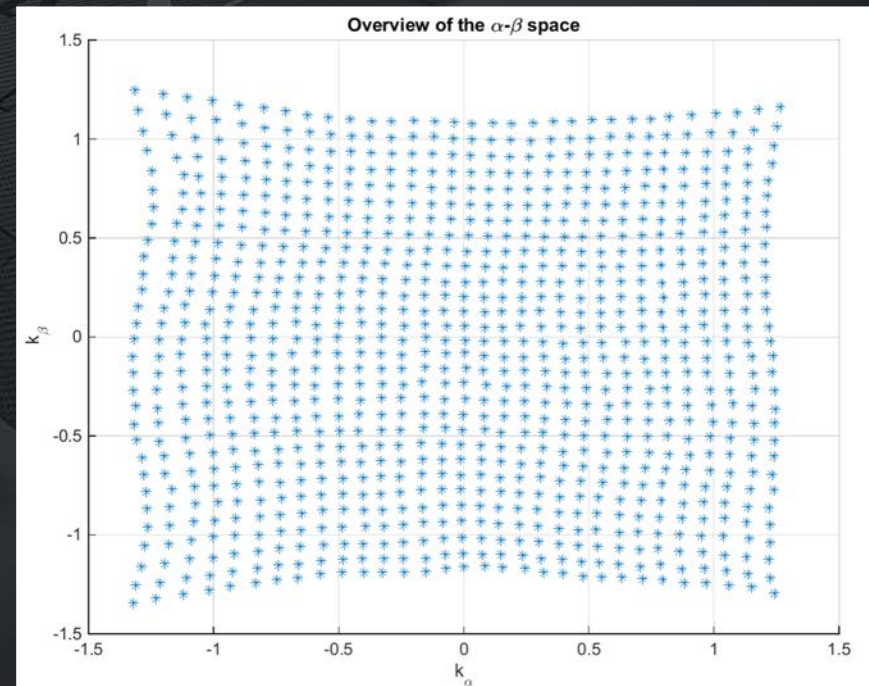

HURRICANE OBSERVATIONS

SO UAS

The S0 is a small, low cost, modular, electric fixed-wing UAS for air deployment from a P-3 Orion “Hurricane Hunter” aircraft. This purpose-built autonomous flight aircraft provides essential measurements in the atmospheric boundary layer of the eyewall of a hurricane.

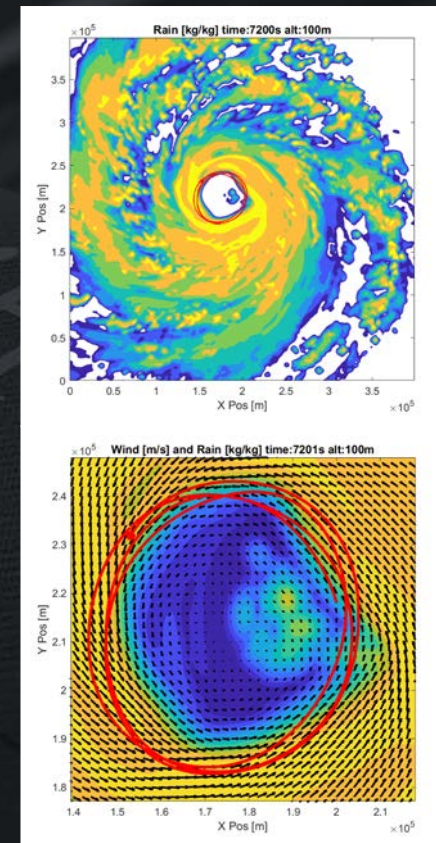
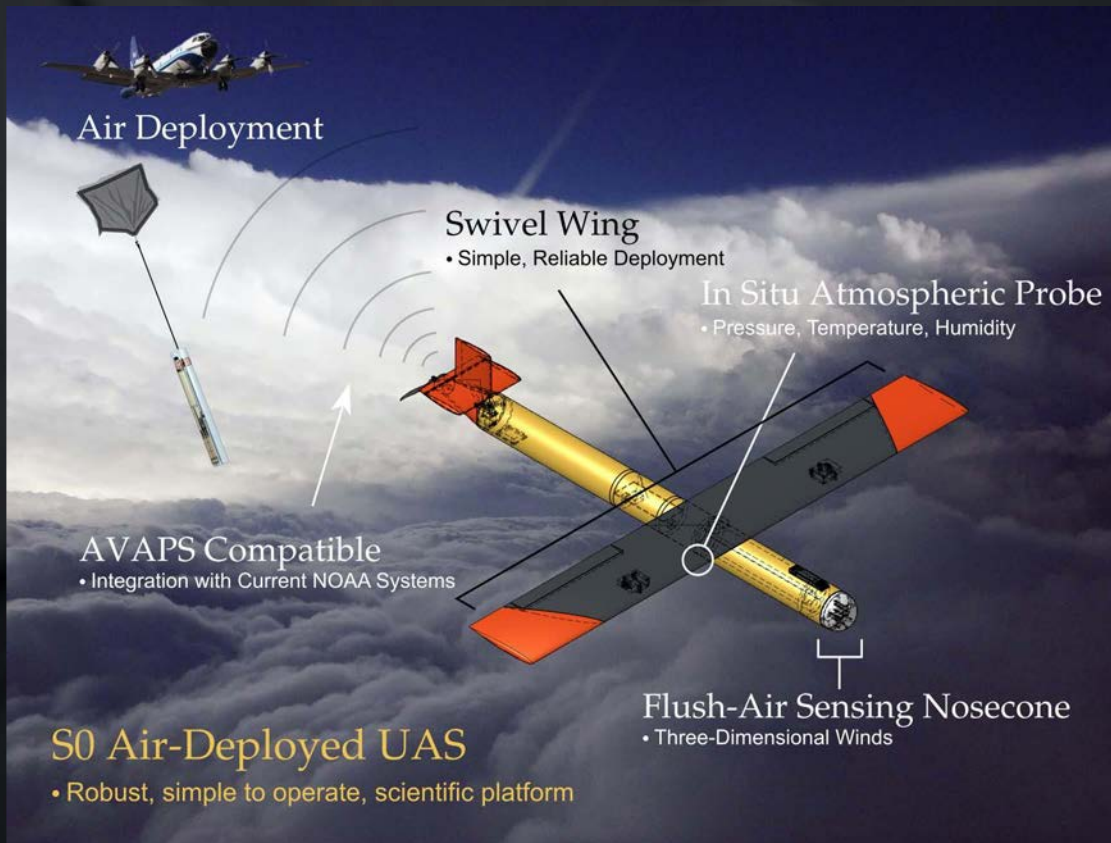

WIND MEASUREMENT

Accurate Measurements in Precipitation

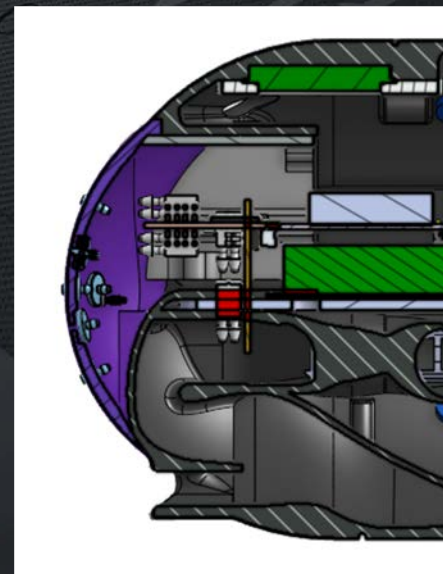
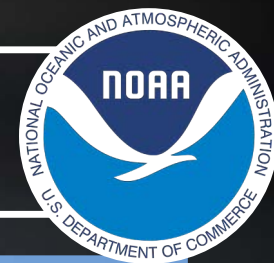

SO AIRFRAME DESIGN

STABILITY ANALYSIS

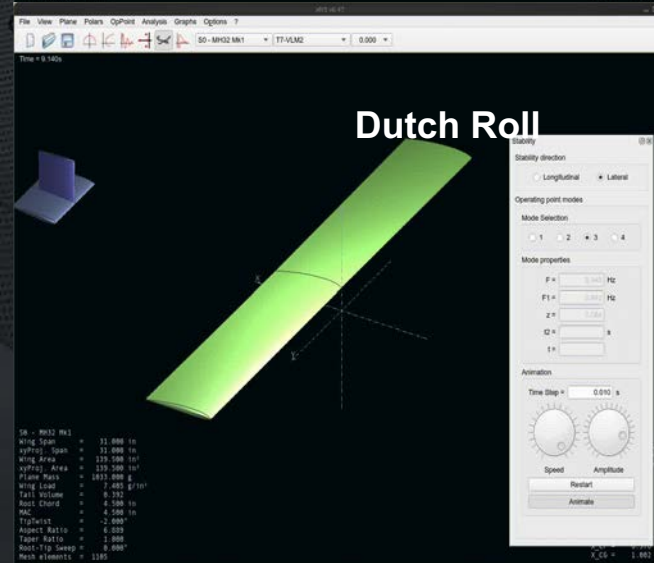
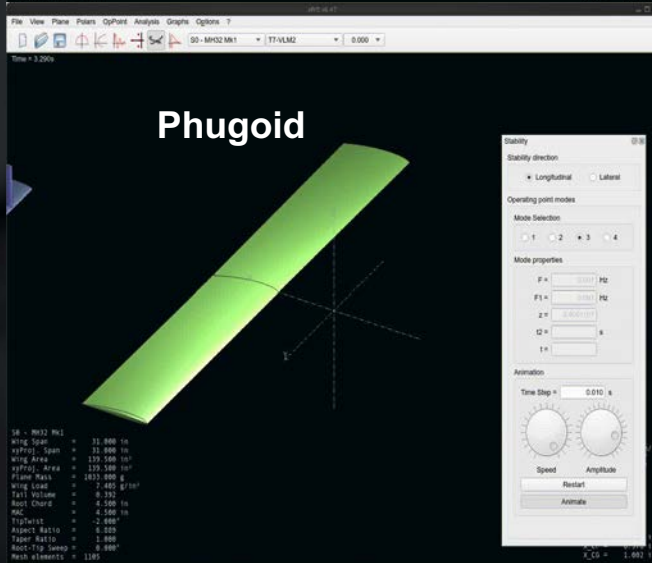
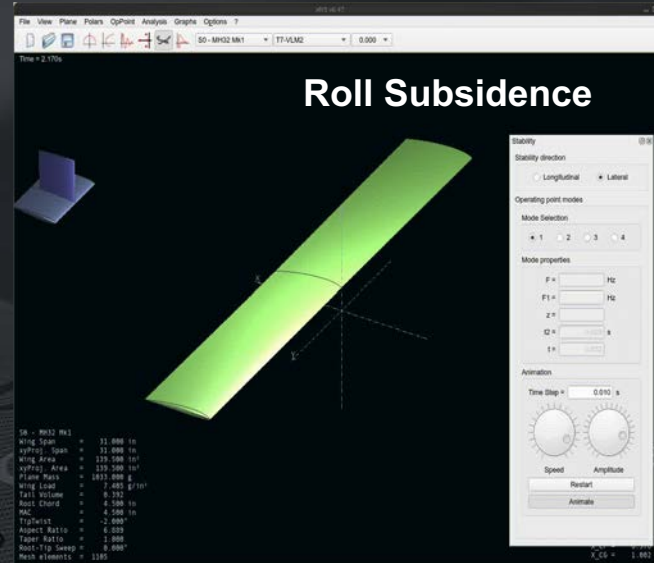
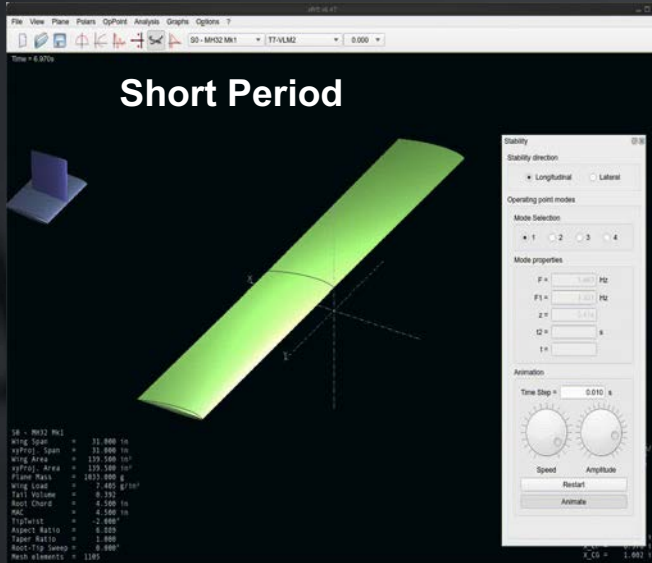

S0 VTOL - PERFORMANCE IN A SMALL PACKAGE



Capable of fitting into a backpack or including several into a small case for persistent measurements, the S0 represents a revolutionary set of capabilities for small UAS

MULTI-MISSION Despite its small size, the S0 can be outfitted with either a real time video system or an atmospheric monitoring setup

PERFORMANCE Capable of dashing > 100mph with a climb rate of > 3000 fpm

INDUSTRY LEADING ACCURACY Calibrated against standardized equipment for the measurement of atmospheric thermodynamics

TIME ON STATION Flights up to 90 minutes, providing monitoring capabilities that far exceed multirotors

SILENT Barely audible even at 200'

CO₂ MAPPING ABOVE VENTS

NASA JPL



- ▶ Volcanoes in Costa Rica have been leaking CO₂ into the overlying ecosystems similar to future atmospheric concentrations
- ▶ This provides a fortuitous natural experiment with which to test the ecosystem responses.
- ▶ First flights in mid January measured CO₂ and plant response around volcanoes in Costa Rica in order to understand the ecosystem response in the tropics, the lungs of the planet.

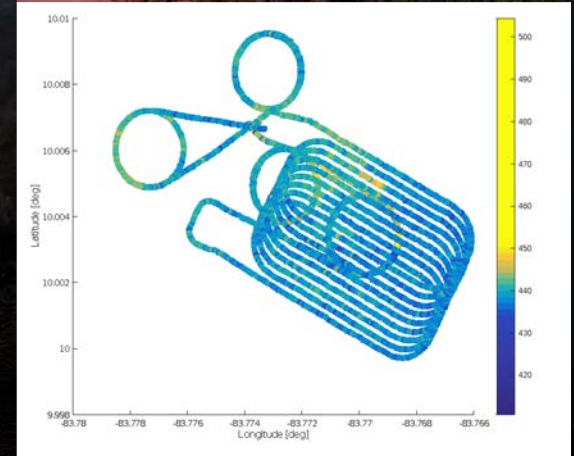
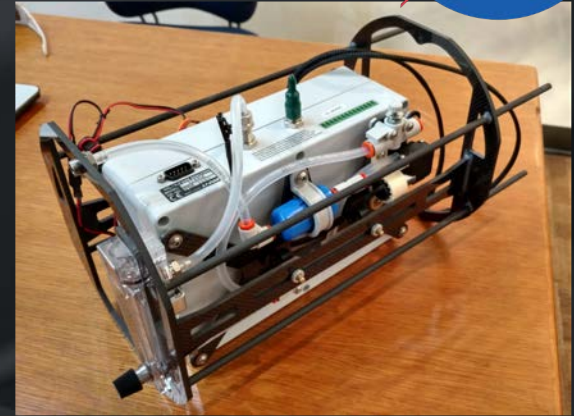

VOLCANO MONITORING

NASA SBIR

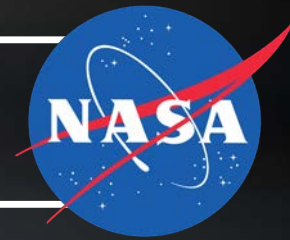

- ▶ Trace gas (SO₂, H₂S, CO₂)
- ▶ Particle size and count
- ▶ P,T,RH, 3d Winds
- ▶ RGB and Thermal Imagery
- ▶ Sample Cassettes



- ▶ NASA SBIR NNX16CP42P
- ▶ Technical Monitor: Dr. Dave Pieri, JPL

VOLCANO MONITORING

NASA SBIR

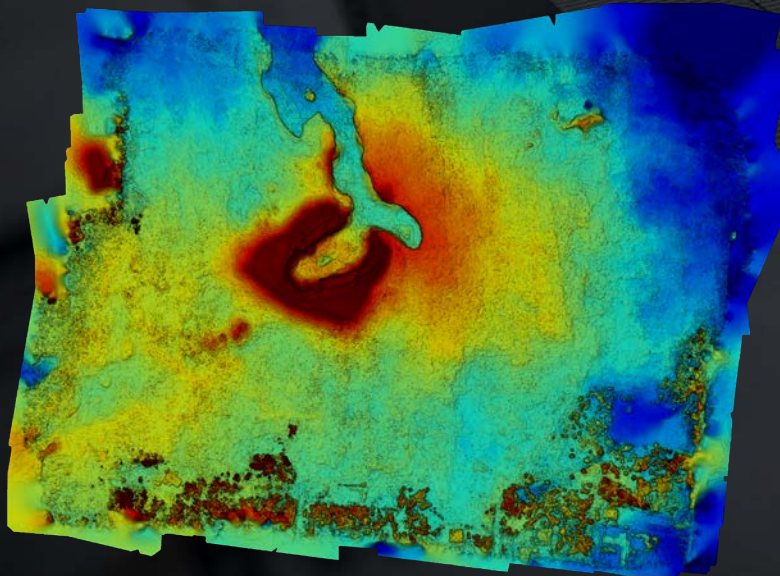
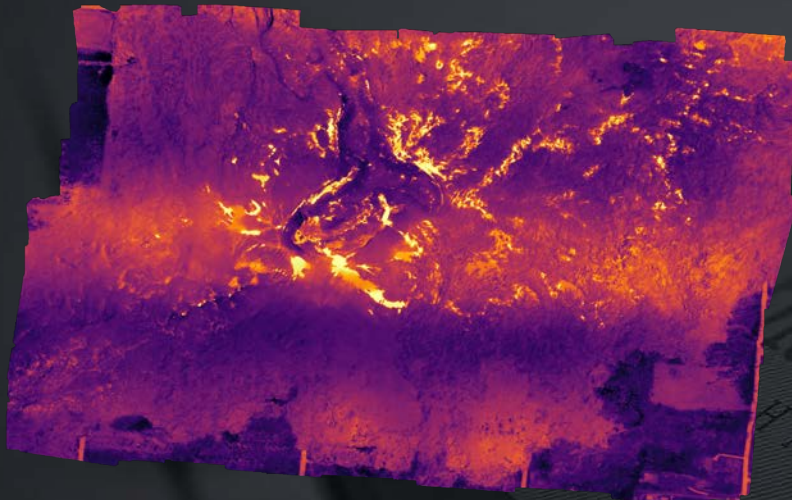
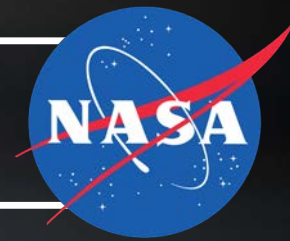

ATMOSPHERIC COMPOSITION

ICE CORE COMPARISON



- ▶ Deployment to Greenland
 - ▶ 6 sample flasks
 - ▶ Telemetry in their own UI
 - ▶ Valve control through Python
 - ▶ Rated to -20 C
 - ▶ Flights up to 14,000'

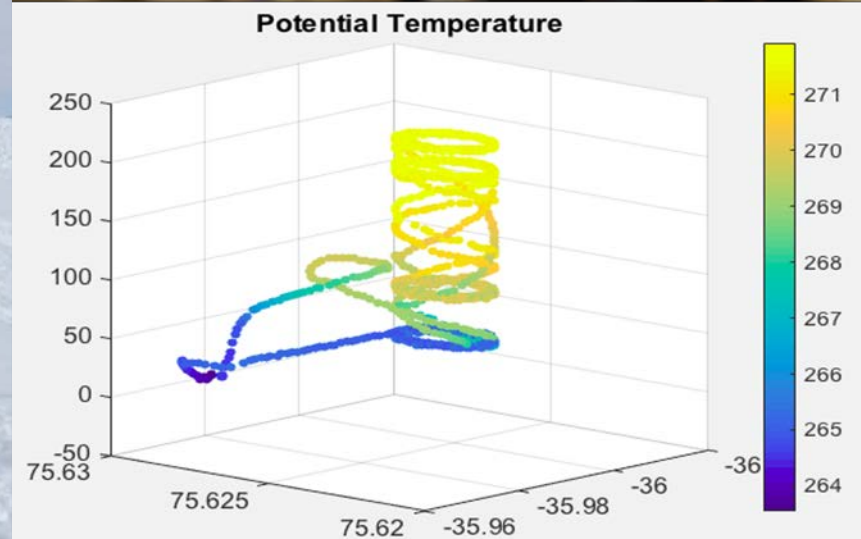
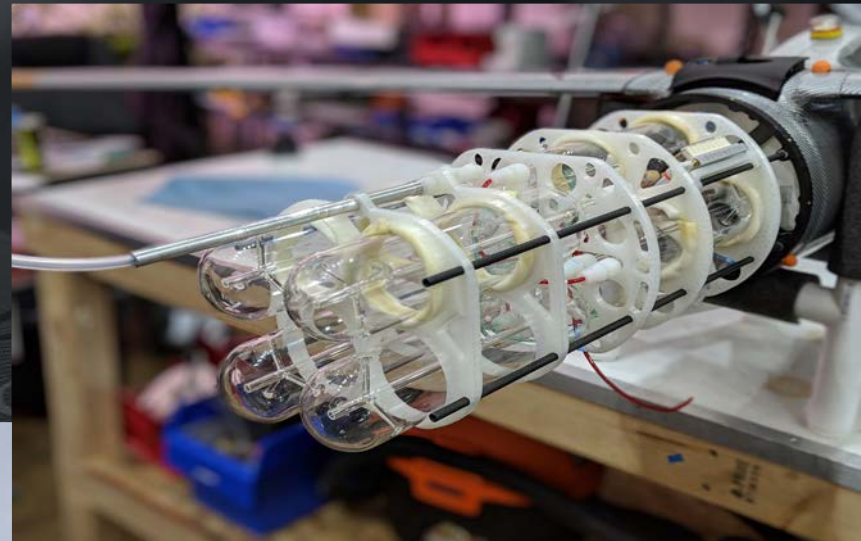

FIRE WEATHER PREDICTION

NOAA NIGHTFOX

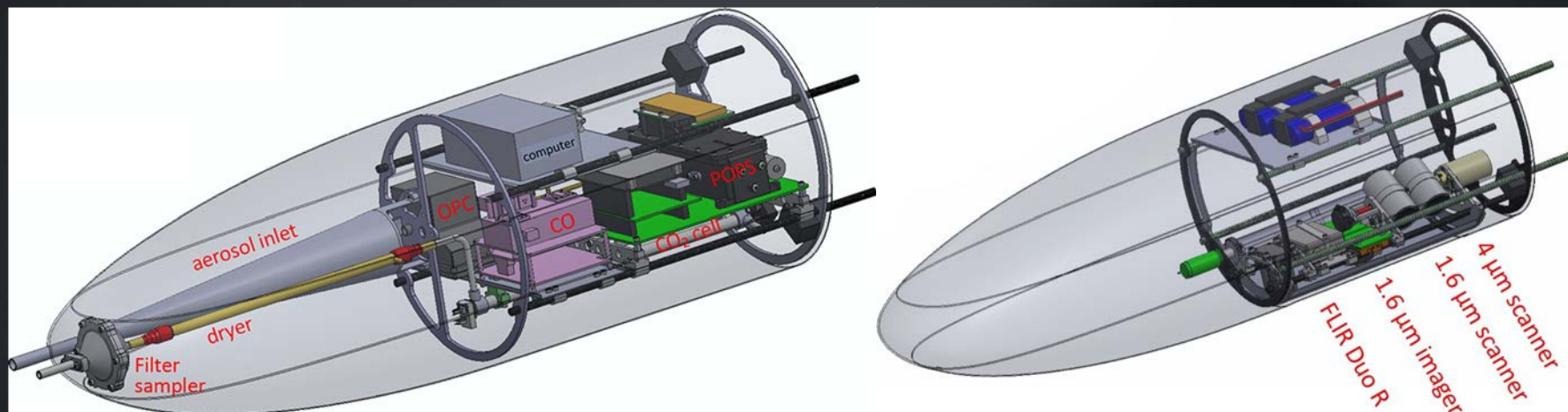
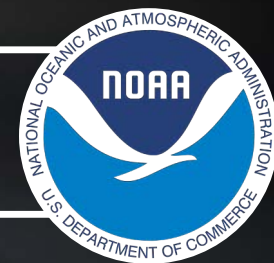

In Situ Exploration of Venus' Clouds by Dynamic Soaring

Jack Elston Mark Bullock Maciej Stachura Sanjay Limaye Sebastien Lebonnois David Grinspoon

Objective

- ▶ Design a glider for exploring the Venus upper Atmosphere
 - ▶ Remain aloft for a minimum of 1 month
 - ▶ Harvest energy from upper atmospheric shear through dynamic soaring
 - ▶ Does not require sunlight
 - ▶ Allows targeted sampling
 - ▶ Can be performed automatically

Work to Demonstrate Feasibility

- ▶ Developed a aircraft simulation
 - ▶ Makes use of probe data as well as the latest GCM's
- ▶ Designed a simple controller to perform dynamic soaring
- ▶ Performed several runs through different regions of the atmosphere
- ▶ Demonstrated net energy increase over time
- ▶ Demonstrated ability to overcome downdrafts

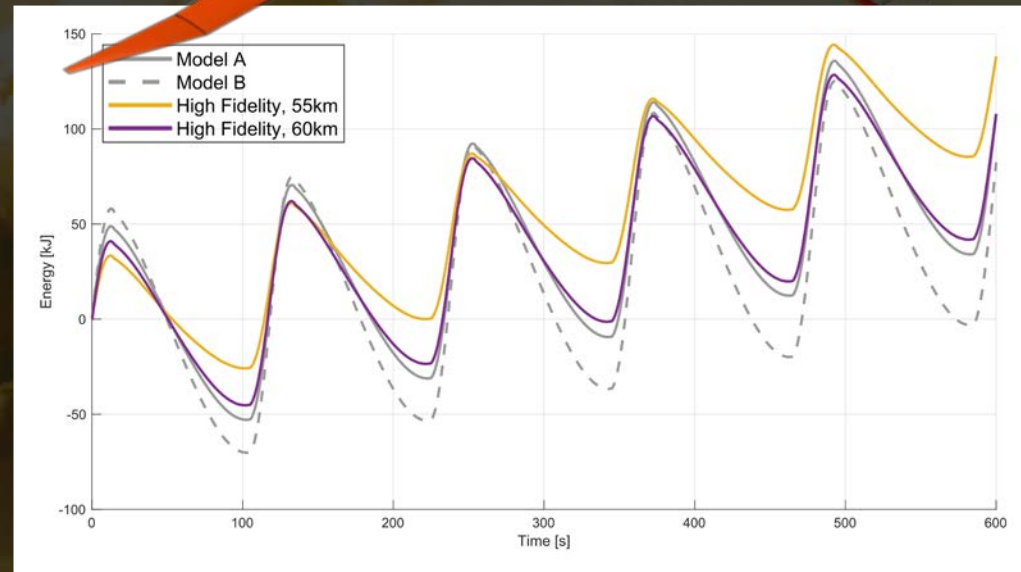
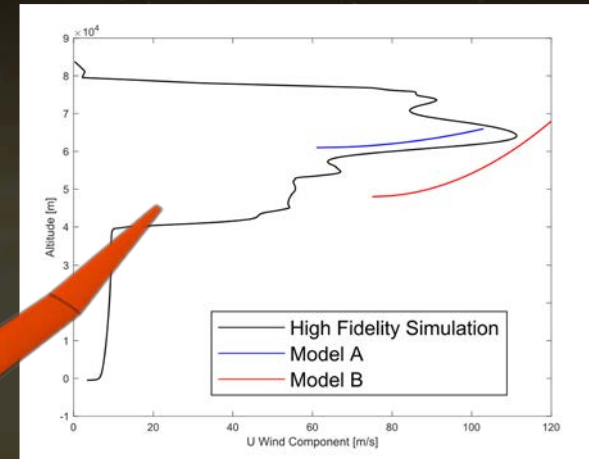
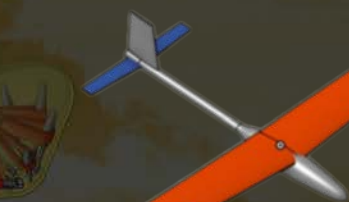
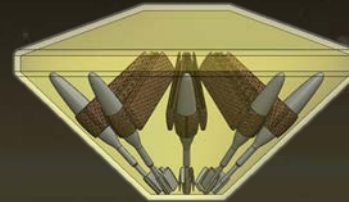

CONTACT INFO

<http://bst.aero> info@bst.aero

